

Taj Mahal, India: Assembly Instructions

PAPER CRAFT

<http://www.canon.com/c-park/en/>



View of completed model

*This model was designed for Papercraft and may differ from the original in some respects.

Assembly Instructions: Seven A4 sheets (No. 1 to No. 7)

*Build the model by carefully reading the Assembly Instructions, in the parts sheet page order.

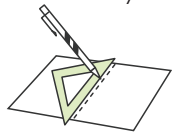

*Hint: Trace along the folds with a ruler and an exhausted pen (no ink) to get a sharper, easier fold.

Assembly Instructions



Mountain fold(dotted line)
Make a mountain fold.



Valley fold(dashed and dotted line)
Make a valley fold.



Scissors line(solid line)
Cut along the line.



Cut in line(solid line)
Cut along the line.

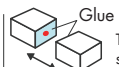

Glue
The glue spot(colored dot) shows where to apply the glue.



Glue spot(Red dot)
Glue parts with the same number together.



Glue spot(Green dot)
Glue within the same part.



Glue spot(Blue dot)
Glue to the rear of the other part.

Tools and materials



Scissors, set square, glue(We recommend stick glue), pencil, used ballpoint pen, toothpicks, tweezers, (useful for handling small parts)

Assembly tip



Before gluing, crease the paper along mountain fold and valley fold lines and make sure rounded sections are nice and stiff.

Caution



Glue, scissors and other tools may be dangerous to young children so be sure to keep them out of the reach of young children.

Before starting assembly: Writing the number of each section on its back side before cutting out the sections is highly recommended. (* This way, you can be sure which section is which even after cutting out the sections.)

→ Indicates where sections should be glued together.

[1] Assemble the rear, nameplate, and front sides of the stand and glue the front and rear sides together.

* Assemble both the left and right sides in the same way.

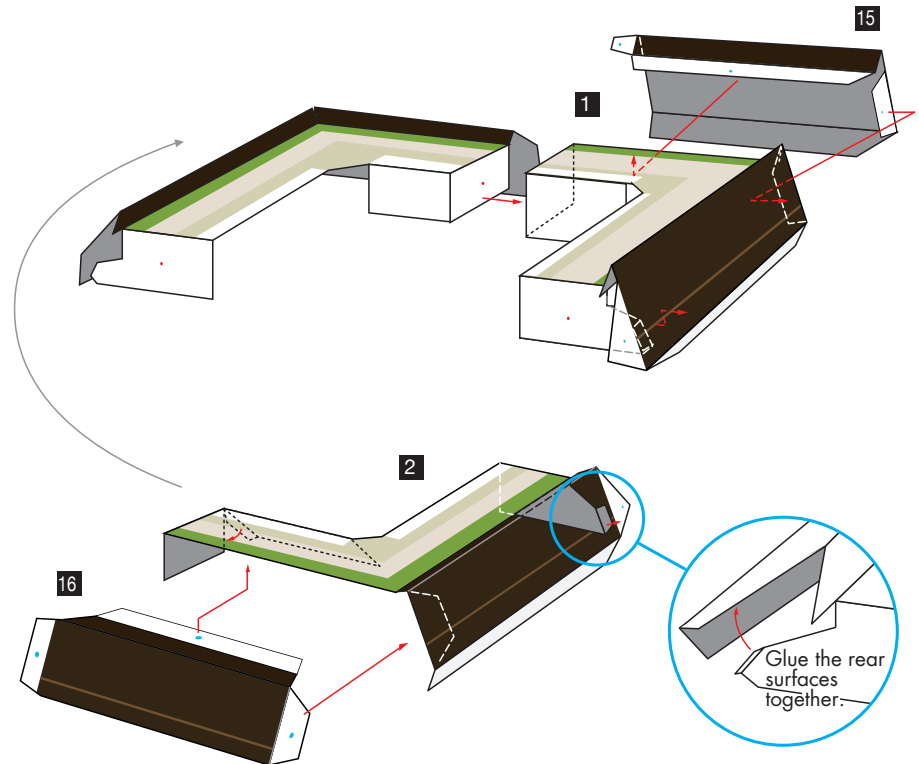

Taj Mahal, India: Assembly Instructions

Canon® is a registered trademark of Canon Inc. © Canon Inc. © A & A Co., Ltd.

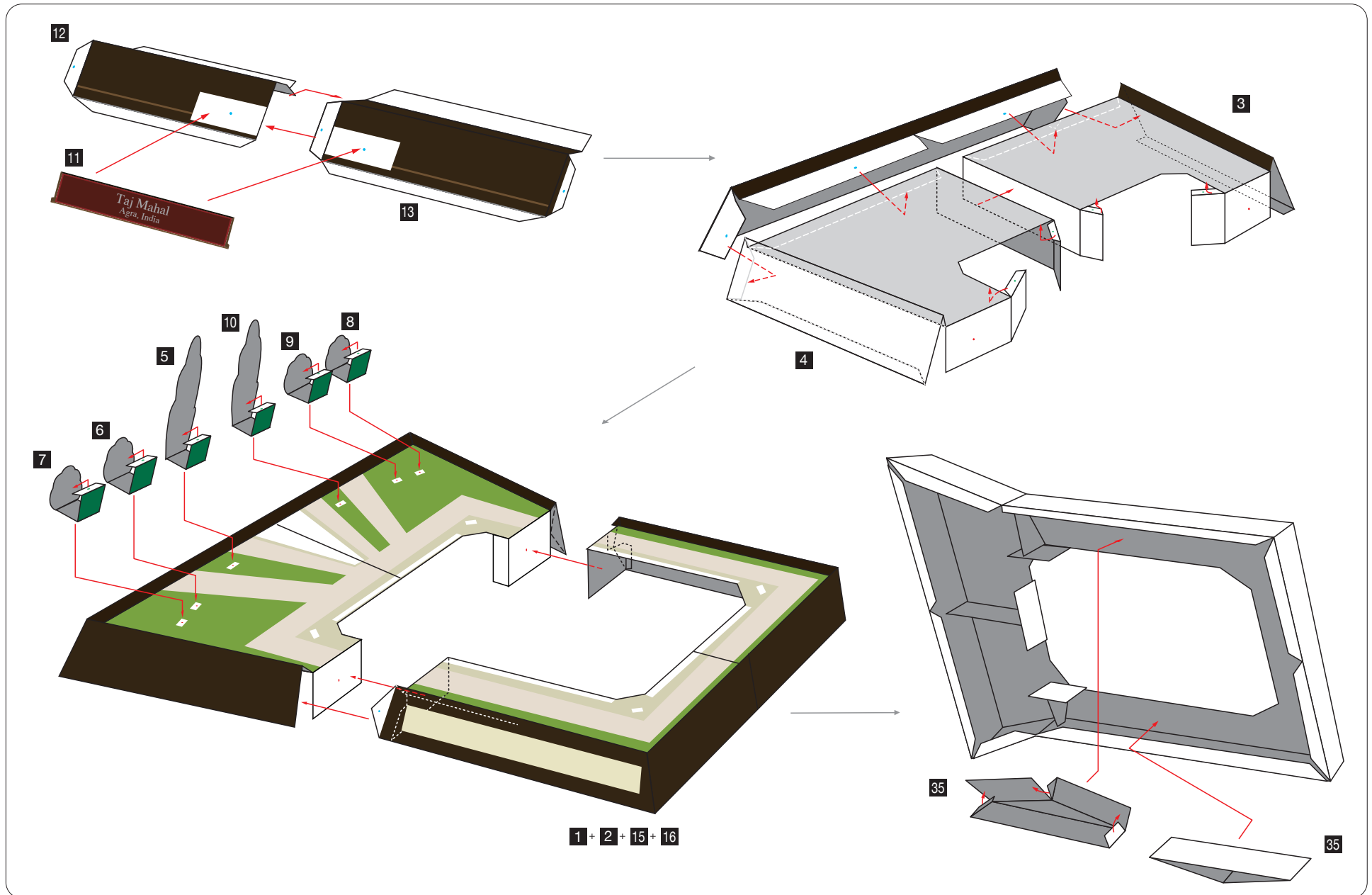

[2] Assemble the stand for the building.

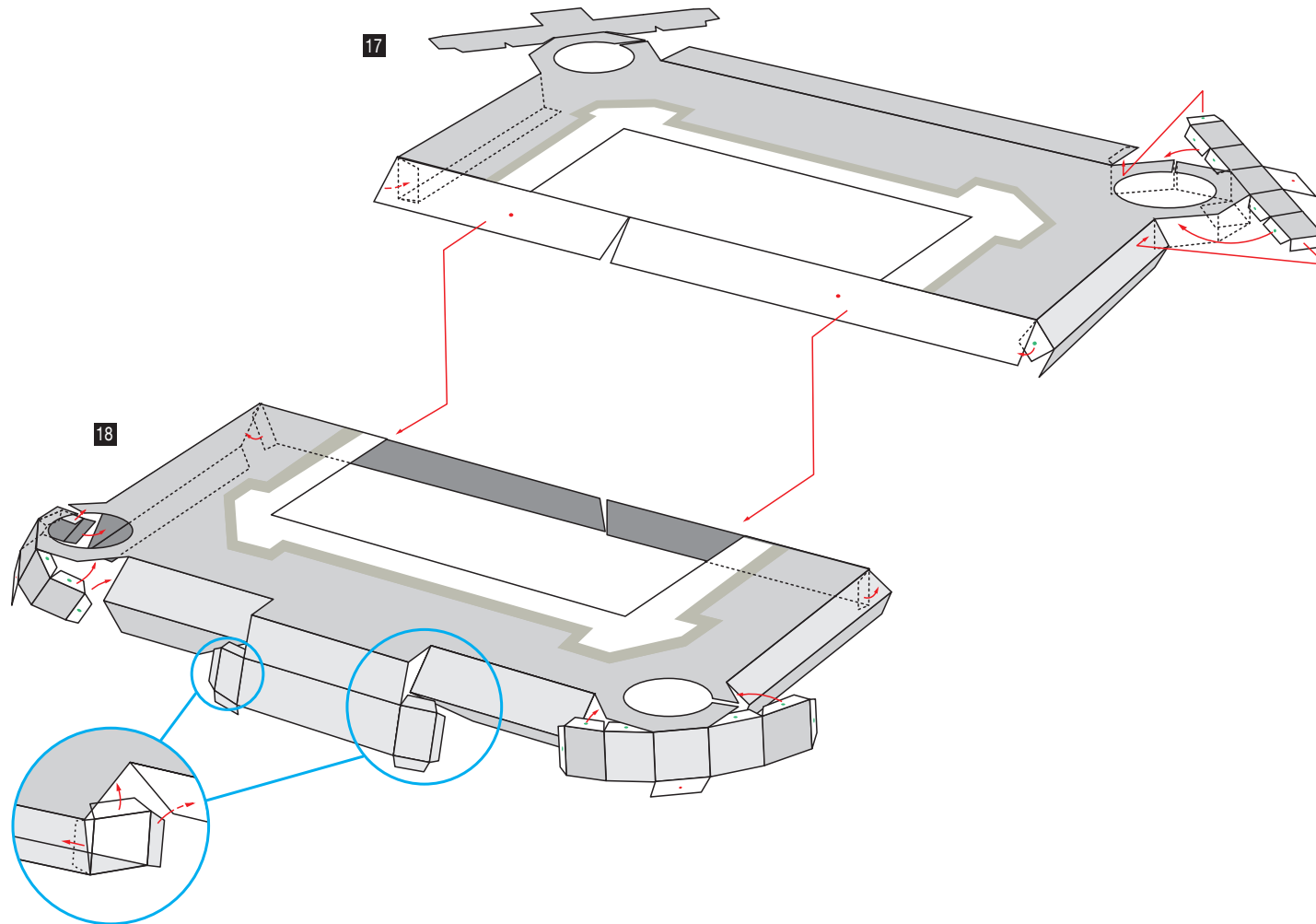

Taj Mahal, India: Assembly Instructions

[3] Assemble the building.

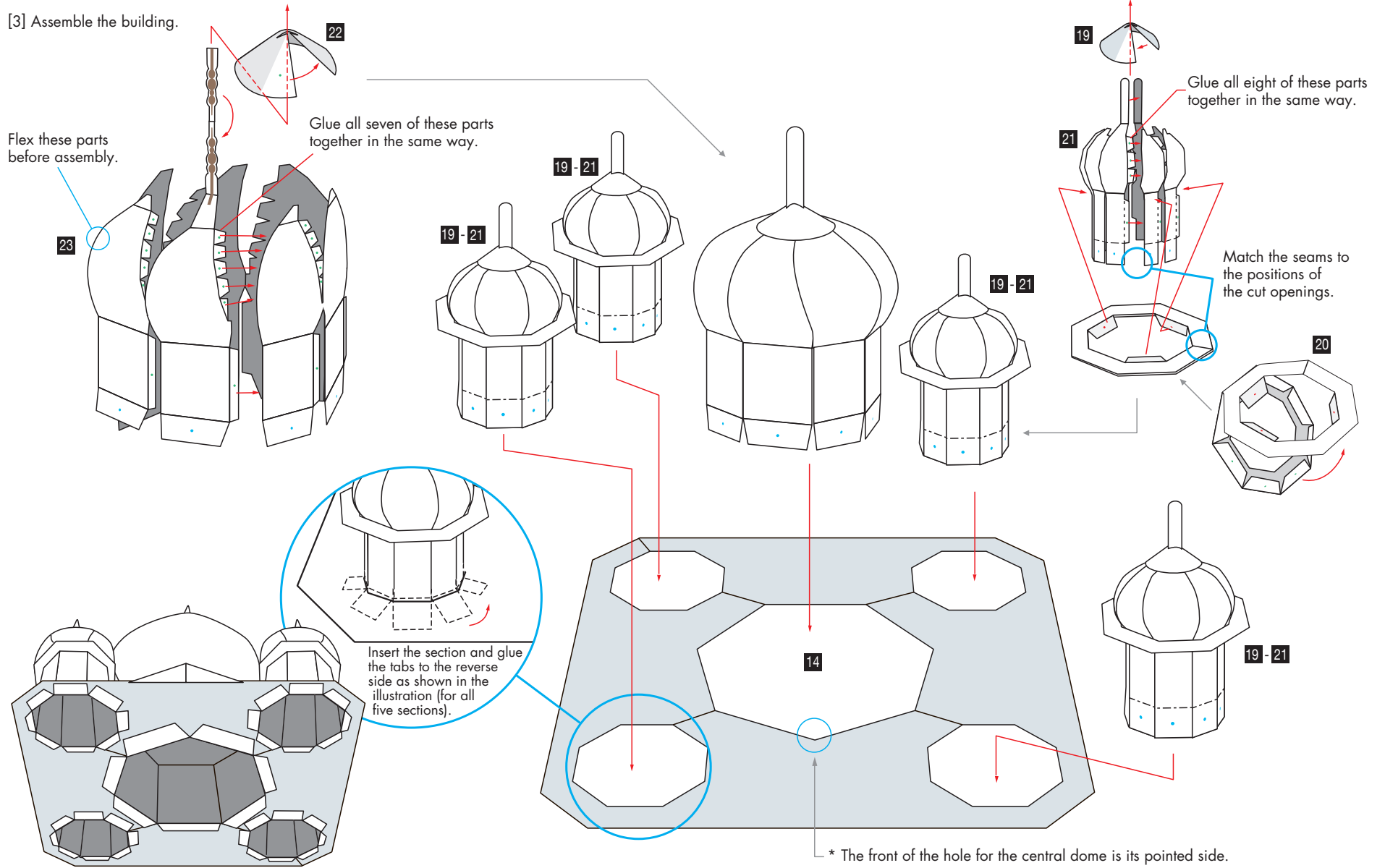

[4] Assemble the building.

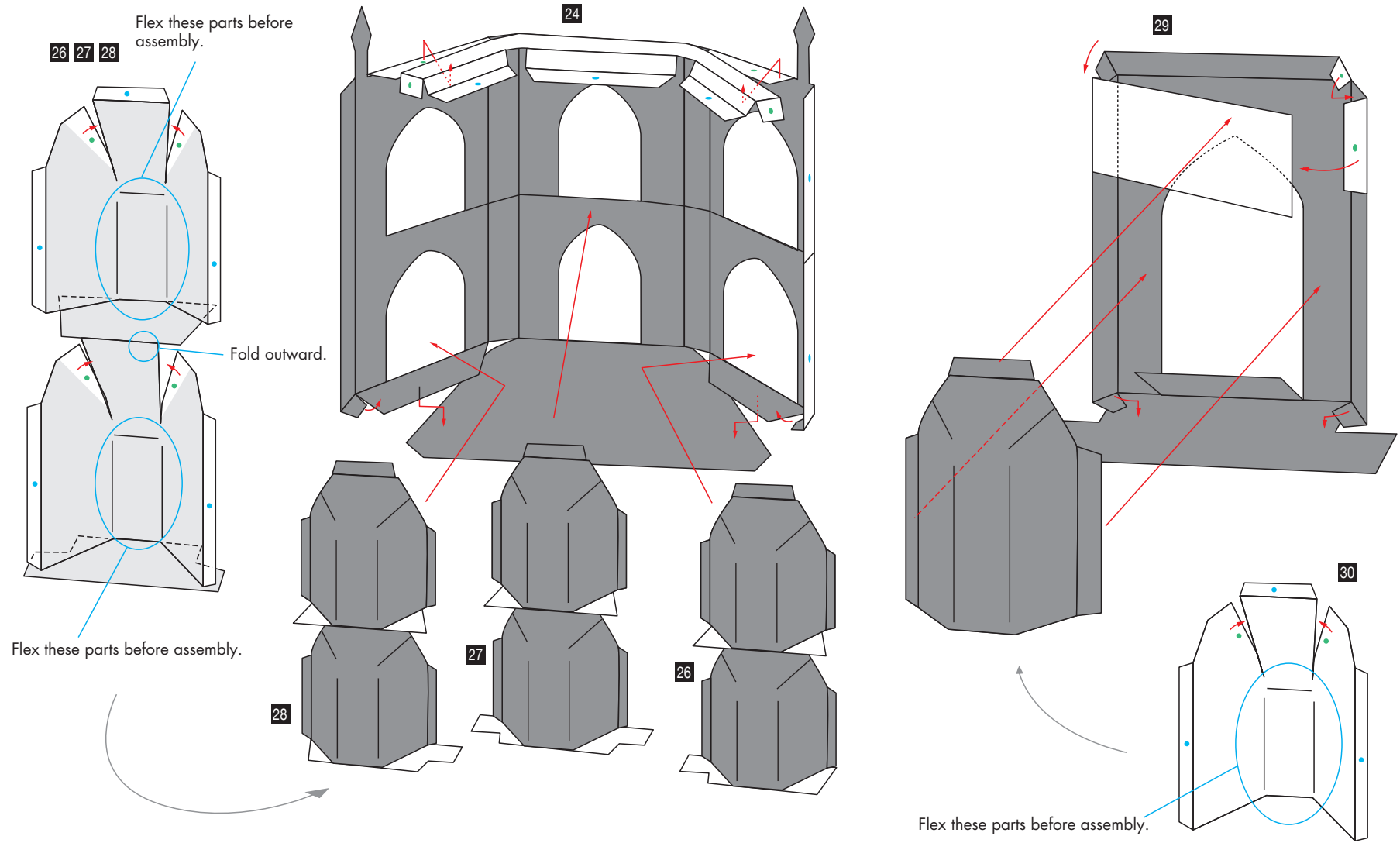

Taj Mahal, India: Assembly Instructions

Canon® is a registered trademark of Canon Inc. © Canon Inc. © A & A Co., Ltd.

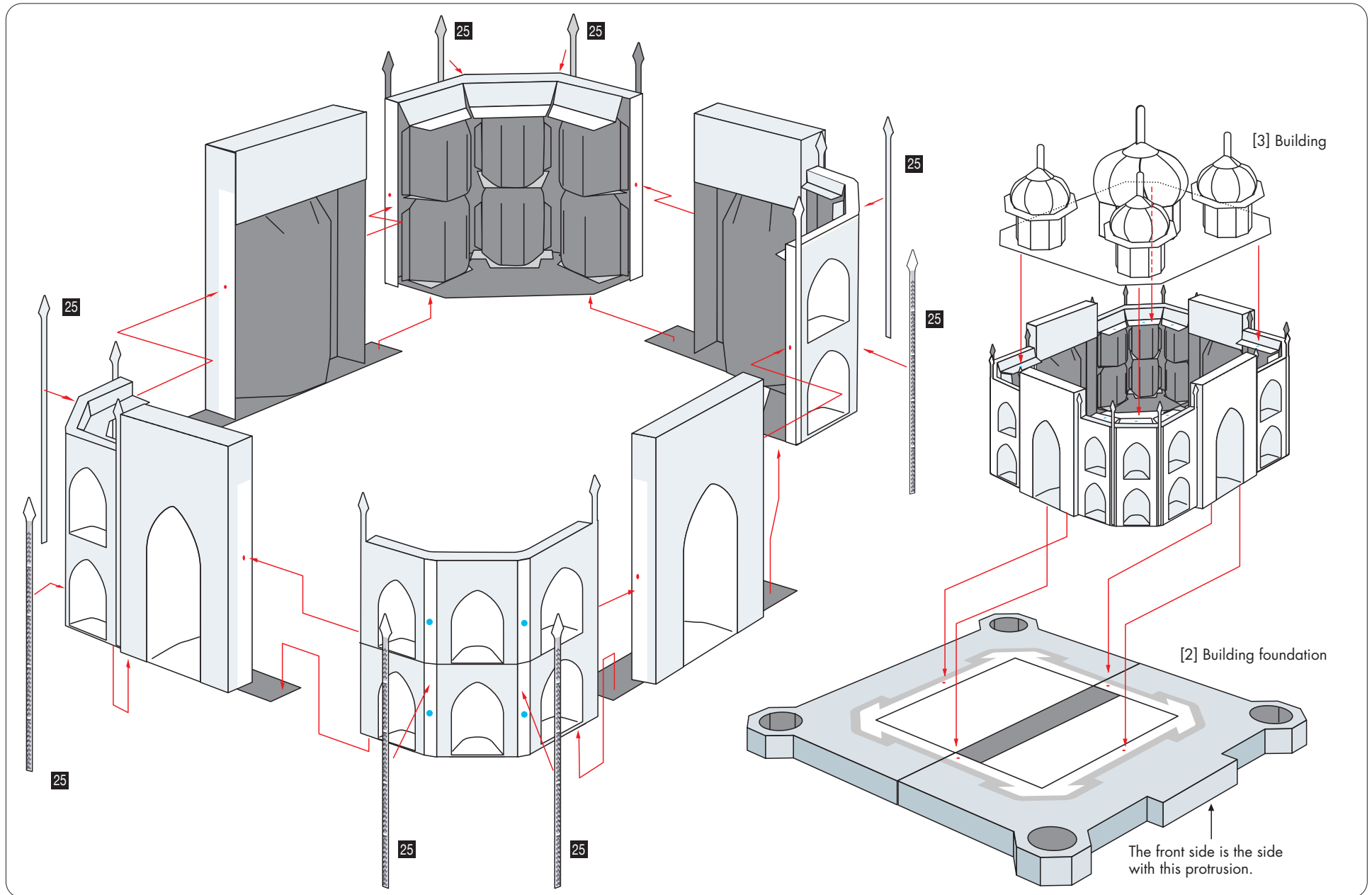

Taj Mahal, India: Assembly Instructions

[5] Assemble the four towers, glue them to the building foundation assembled in step [2], then glue these to the stand assembled in step [1].

